

INSTALLATION MANUAL

Galio Insert Manual

G20/G25 (Natural Gas) G30/G31 (Propane-Butane/Propane)

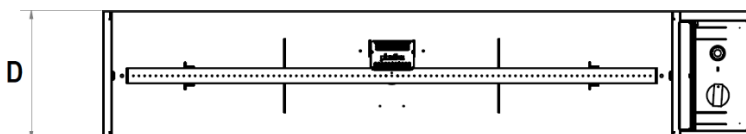
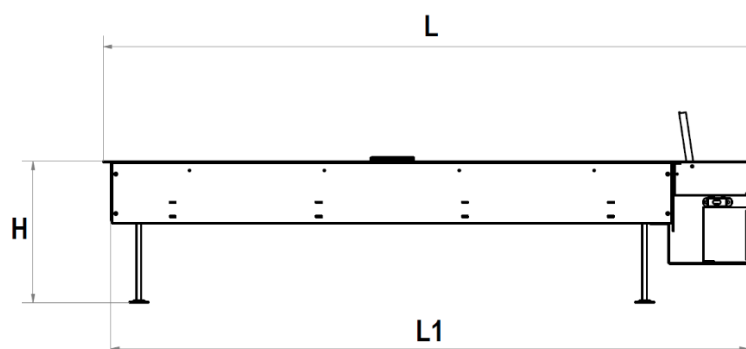

	H	L	L1	D
[mm]	232	1160	1132	230

**Manufactured by
Planika Sp. z o.o.
Bydgoska 38
86-061 Brzoza
Poland**

IT IS OBLIGATORY TO READ AND KEEP THIS INSTRUCTION MANUAL.

TABLE OF CONTENTS

1. INTRODUCTION	3
2. SAFETY INSTRUCTION	3
2.1 Safety instruction regarding the use of the gas cylinder	4
3. INSTALLATION	4
3.1. Box contents	4
3.2. Unboxing and installation	5
4. MONTAGE	6
4.1 Directions of how to design a housing for the fireplace	7
4.2 Possible housing variants	8
4.2.1 Situations in which montage of glass screen protection is mandatory	8
4.2.2. Situations in which the glass screen montage is forbidden	8
4.3 Gas cylinder montage	8
5. INSTALLATION OF THE GAS LINKAGE	10
5.1 Natural gas connection	10
5.2 Connection and replacement of the gas cylinder (LPG version)	10
5.3 Pressure regulator replacement (LPG version)	13
6. OPERATING INSTRUCTIONS	14
6.1. Start-up of the device	14
6.2. Regulation of the flame size	15
6.3. Device shutdown	16
7. TESTING	17
7.1. Checking for gas leaks	17
7.2. Checking the flame appearance	17
8. MAINTENANCE AND UPKEEP	18
8.1. Testing and cleaning	18
8.2. Glass cleaning	18
9. TROUBLESHOOTING	18
10. TECHNICAL SPECIFICATION	19
11. MANUFACTURER'S CONTACT DETAILS	19

1. INTRODUCTION

The Galio Insert Manual fireplace is a decorative fuel-effect gas appliances intended only for outdoor use. It is obligatory to acquaint oneself with the below installation manual and user's manual before committing to the installation and use of the Galio Insert Manual fireplace. This manual is to be kept safe for the lifetime of the device.

2. SAFETY INSTRUCTION

- Read the instruction before using the device.
- Use only outdoors.
- The Galio Insert Manual is not a free-standing device and is destined to be housed.
- The montage of the device must take into account its trouble-free removal in case of service.
- Do not start up the device before it's placed safely into the prepared housing.
- The Galio Insert Manual fireplace should be installed and controlled annually according to the below installation manual as well as enforced national and local laws regarding gas safety (installation and use).
- One needs to assess whether the data on the product plaque complies with the local type of gas and pressure.
- Do not change the structure of the device or its sealed elements nor modify the default settings of the Galio Insert Manual fireplace.
- Do not set any additional imitation blocks nor any glowing coal fragments on the burner or in the combustion chamber.
- A ventilation grid or slot with a ventilation area of 150cm² is required at the base of the housing. A device without the grid or slot for ventilation will function incorrectly causing a threat of damaging the unit or causing a fire.
- A CO₂ or a powder fire extinguisher needs to be placed near the device.
- During the first ignition the Galio Insert Manual fireplace needs to be burnt on maximum level for a few hours in order for the elements to acquire correct temperature and for the remains of paint, lacquer and lubricant to evaporate.
- Do not move the device while it's working.
- The Galio Insert Manual fireplace was designed for decorative purposes. The surface of the Galio Insert Manual fireplace (including the optional glass screens) may get hot (up to 100 degrees Celsius). **WARNING!**: parts of the device that are easy to reach may be very hot. Keep children away from the device.
- Some variants of housing for the device may require installing additional toughened glass screens (provided separately).
- Install the fireplace away from flammable materials.
- When the Galio Insert Manual fireplace is on it's not to be exposed to rain.
- When not being used the Galio Insert Manual is to be protected from atmospheric conditions and the main valve of the gas cylinder needs to be turned off.
- All parts of the Galio Insert Manual fireplace are made of stain resistant material.
- Never leave a turned on Galio Insert Manual without supervision.
- The Galio Insert Manual fireplace needs to be installed in a place inaccessible for children, unauthorised persons or animals for the direct contact with the flame or hot parts of the device to be impossible.
- In case of heavy wind the Galio Insert Manual fireplace needs to be immediately turned off and one needs to wait until the heavy wind passes.
- In case of noticing any sort of gas leaks the fireplace as well as the main valve of the gas cylinder need to be turned off.
- After use turn off the gas cylinder valve.

2.1 Safety instruction regarding the use of the gas cylinder

- Use only the type of gas and pressure specified by the manufacturer.
- The gas cylinders should always be placed in a vertical position – during use and transport.
- Always store the gas cylinder in an easily accessible place to allow its immediate turn-off.
- During the installation process do not allow an open flame or any ignited object to reach the gas cylinder.
- The gas cylinder should be in a distance not shorter than 1,5 metres away from the Galio Insert Manual fireplace.
- Leaks should be found with the use of a cleaning liquid and water. If bubbles form on the surface that means that there's an existing leak.
- Always use a pressure regulator between the gas cylinder and the device. Replace the pressure regulator every 5 years. The allowed pressures are: 30mbar, 37mbar (recommended), 50 mbar. Use only regulators complying with the European EN16129 Norm.
- Use only approved and certified gas connection linkage. Replace the linkage every 2 years.
- The elastic linkage connecting gas to the fireplace is to be led away from sharp edges and hot surfaces. Refrain from bends and twists of the elastic connection on its full length.
- Remember that the LPG bottle should be stored in a well-ventilated place. LPG gas is heavier than air and its accumulation near the surface may generate an explosive mixture.
- The housing in which the LPG bottle is (optionally) placed needs to have an appropriate ventilation. The housing needs to have an upper ventilation slot above the top of the bottle (of an area min 1/100 of the area of the base of the housing) and a lower ventilation slot (of an area min 1/50 of the area of the base of the housing).
- The gas cylinder needs to be shut if the fireplace is not being used.
- Filling the gas cylinders is to be commissioned to certified gas filling stations.
- Replacement of empty bottles for full ones is to be conducted only in authorized locations.

3. INSTALLATION

3.1. Box contents

- 1x complete gas fireplace
- 1x AAA Batteries
- 4x bag of decorative stones
- 1x 4 metre rubber gas linkage – installed (only LPG version)
- 1x pressure regulator (37mbar) – installed (only LPG version)
- 1x installation manual
- 1x user's manual

3.2. Unboxing and installation

- The contents of the boxes need to be carefully unwrapped from the foam foil.
- Remove the bags with decorative stones from the burner reservoir and place them away from it.
- Remove the Styrofoam placed on the unit.
- Check the completeness of the elements with the contents list.
- Make sure that the insert nor its elements weren't damaged during the transportation (if they were, notify the supplier).
- Install the Galio Insert Manual fireplace in the prepared housing made according to the montage specification.
- The decorative stones are to be scattered evenly around the reservoir to completely cover the burner of the fireplace.
- **WARNING!!!** The stones may not cover or be placed inside and on the top of the protective basket of the ignition unit. (Photo 1)

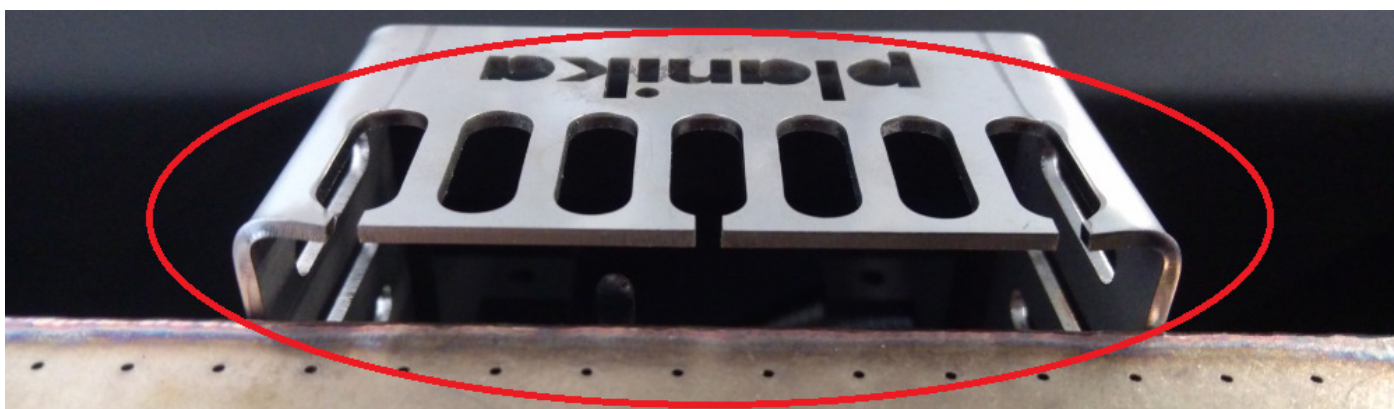

Photo 1

- In the case of Galio Insert Manual powered with natural gas, to obtain the optimum image of the flame, cover the burner with a single layer of decorative stones leaving some spaces uncovered of approximately every 10 cm (Photo 2).

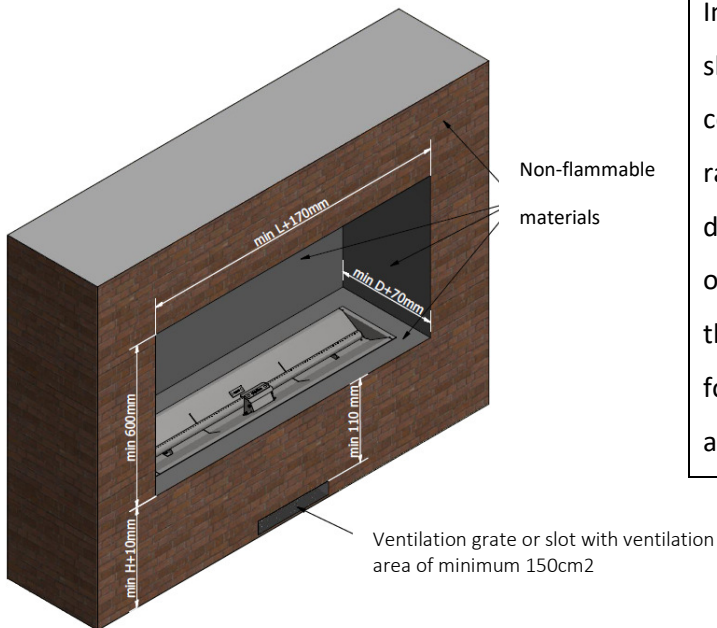

Photo 2

- If all the points were completed according to the instruction the gas cylinder can be now connected.

4. MONTAGE

WARNING!!! All elements above the fireplace need to be made of non-flammable materials.



In accordance with fire safety measures there should be no flammable objects in direct contact with the device nor within a 1 metre radius from the fire. Additionally, Planika doesn't recommend placing heat-sensitive objects above the fireplace as it may shorten their lifetime. Planika will not be responsible for any damage caused by high temperature affecting objects installed above the fire.

- The dimensions of the housing are to be chosen according to the technical drawings and a ventilation grid or slot – with ventilation area min 150cm² – needs to be placed near the base of the unit, minimally 110 mm below the burner surface.

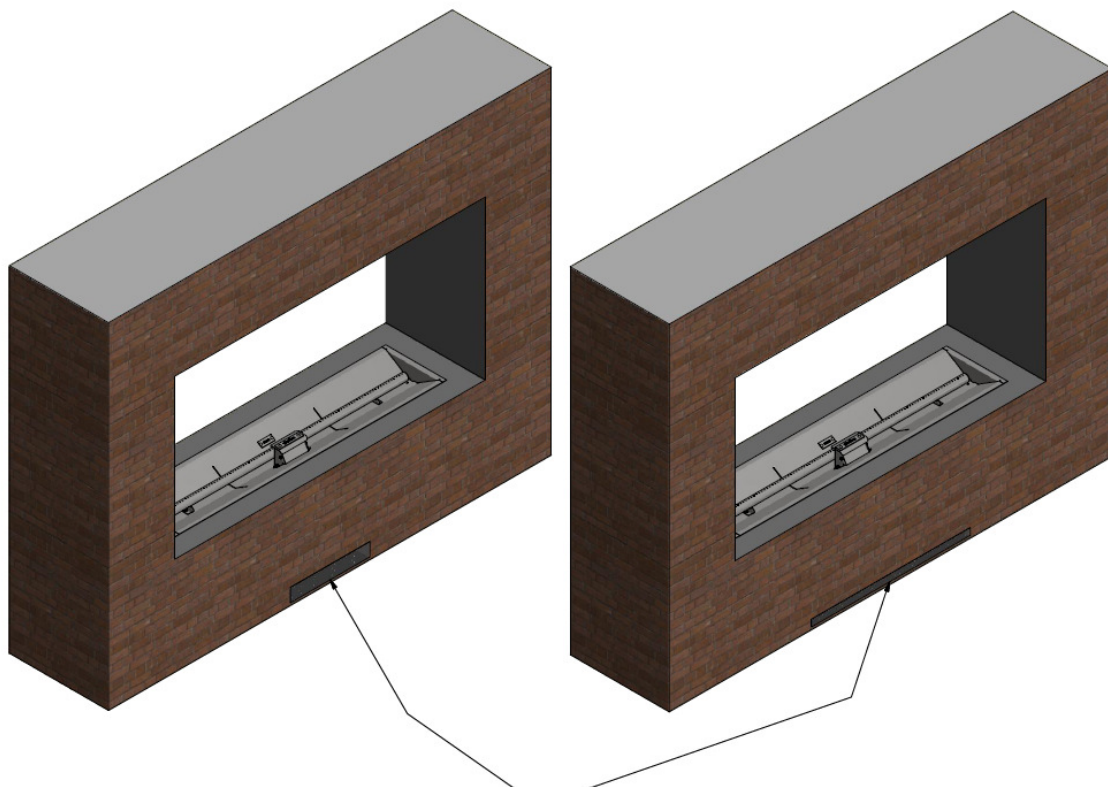

The dimensions and shape of the ventilation grid may be designed according to client specifications however both the minimum ventilation area of 150 cm² as well as minimum distance from the edge of the housing of 110 minimum need to be observed.

- If a hood is placed above the burner it needs to be made of non-flammable materials and a minimum distance of 60 cm from the surface of the burner needs to be observed. **WARNING!!!** If the housing is devoid of a diagonal hood above the burner one needs to remember that all surfaces inside the housing exposed to contact with hot air need to be made of non-flammable materials.
- It is not permitted to use a device which is not housed in some way.

4.1 Directions of how to design a housing for the fireplace

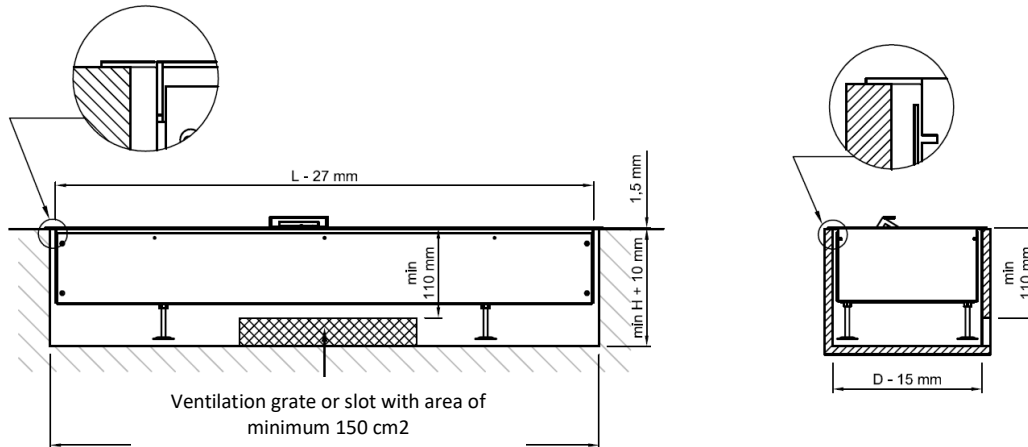

- Make the cavity for the insert according to the below outline. When preparing the cavity make sure the surface on which the insert is placed is well-levelled as there is no option of levelling out the insert.

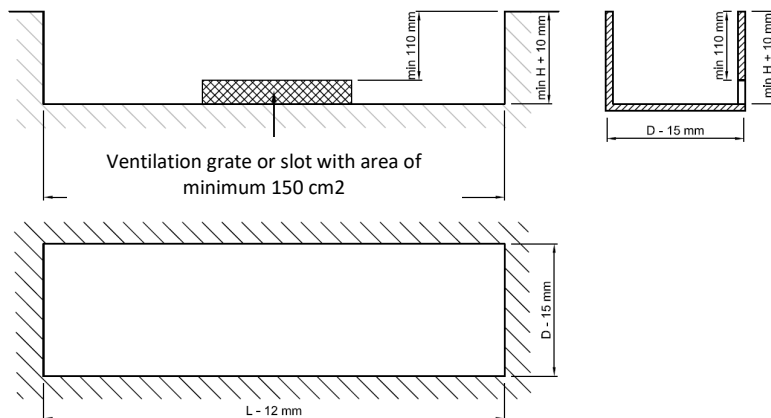

- The level difference between the edges of the fireplace cannot exceed 2 mm. Incorrect levelling may cause incorrect operation of the device and in a worst case scenario, a fire.

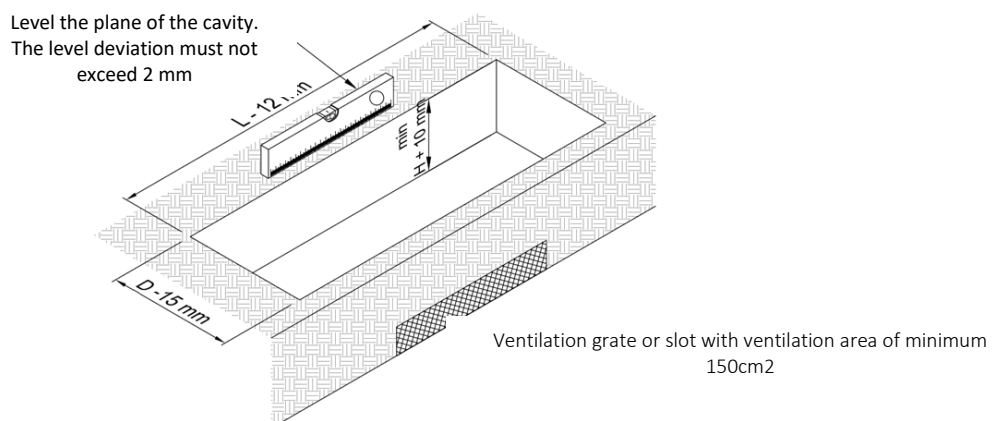

4.2 Possible housing variants

4.2.1 Situations in which montage of glass screen protection is mandatory

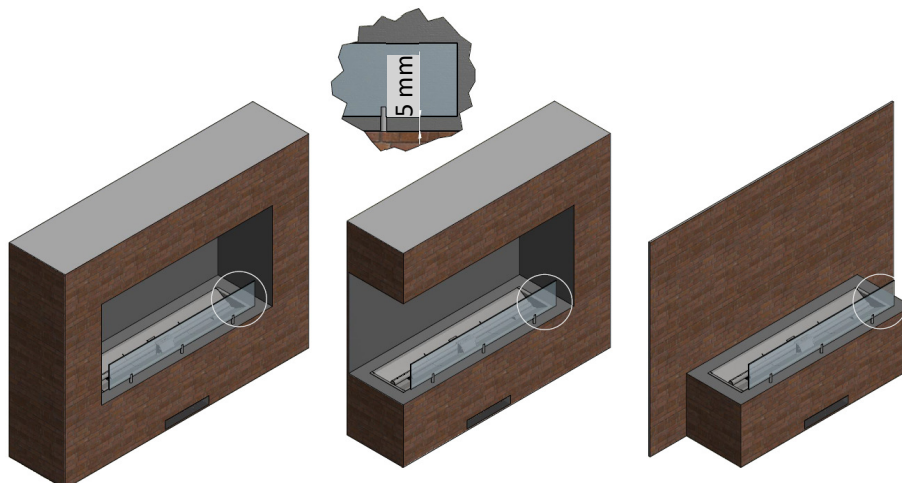

4.2.2. Situations in which the glass screen montage is forbidden.

The montage of toughened glass screen panels is advised (and recommended) on both sides of the fireplace in this case or leaving those sides without the montage of the glass screen. In this case one has to put an emphasis on safety measures and disallow children, unauthorised persons and animals to have a direct contact with the fire.

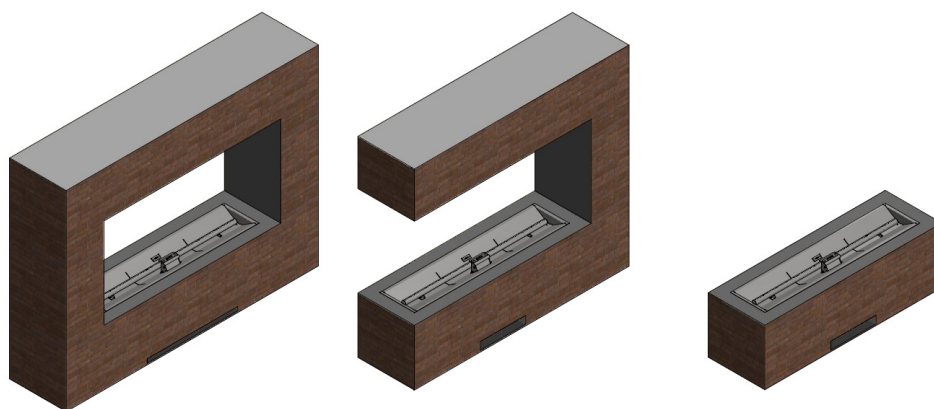

4.3 Gas cylinder montage

WARNING! It is crucial to manufacture a slot in the side of the housing where the insert is placed for the gas linkage and the pressure regulator (**only in case of LPG version**).

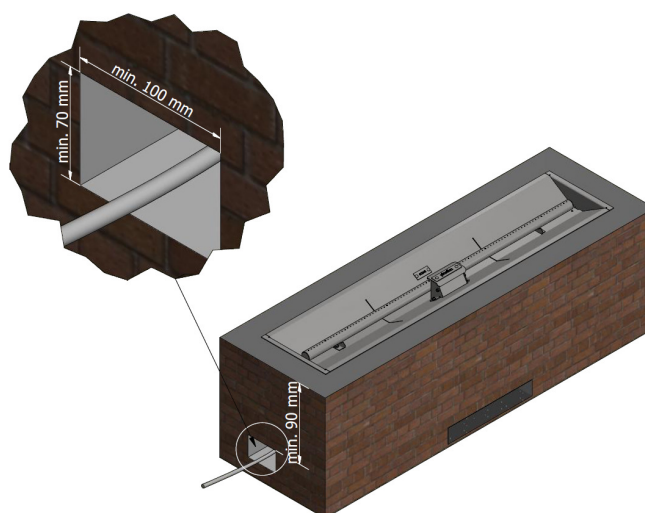

- The gas linkage attached to the device allows to place the gas cylinder maximally 3 metres away from the connected control panel, however it cannot be placed nearer to the device than 1,5 metres.

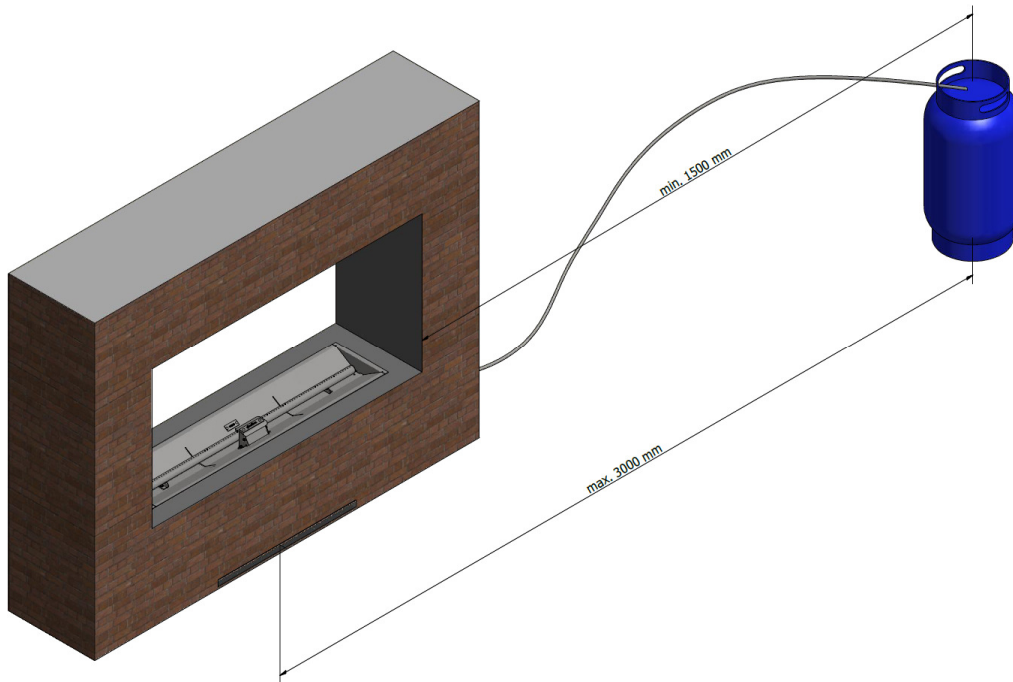

- The optional housing for the gas cylinder cannot be airtight and has to be correctly ventilated. The housing needs to have an upper ventilation slot above the top of the bottle (of an area min 1/100 of the area of the base of the housing) and a lower ventilation slot (of an area min 1/50 of the area of the base of the housing). The dimensions of the housing may vary to accommodate different types and dimensions of the gas cylinders however they also have to be sufficient for hassle-free installation of the gas cylinder.

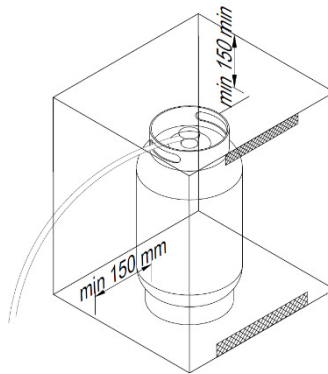

WARNING!!!

- After making sure that the device has been correctly installed acquaint yourself with the attached User's Manual.
- Only after acquainting yourself with the User's Manual and correctly attaching the gas linkage may you start the device.
- If in future a need arises of having to take the insert out of the housing it may only be done when the device is turned off and cooled down and the valve on the gas cylinder is closed.
- Keep this instruction manual for the lifetime of the device.

5. INSTALLATION OF THE GAS LINKAGE

Warning!!! The montage and service needs to be conducted by a qualified professional, a company or the gas supplier.

5.1 Natural gas connection

First and foremost, make sure that the connecting device is designed to supply a gas suitable for the type placed in the gas installation. All necessary information regarding the desired parameters of the gas are found on the rating plate of the device. Before connecting the gas supply, it is necessary to blow them to remove any remaining metal filings and other contaminants from inside. Automatic gas control system should be protected from moisture and dust. These factors may cause irreparable damage to the individual components. The pipe supplying gas to the fireplace should be equipped with a ball valve with a recommended diameter of 1/2 inch. The individual elements of the gas installation cannot be sealed using Teflon tape or PTFE tape.

The gas valve on the gas pipe must be installed in accordance with applicable national regulations. Before connecting the gas, make sure that the gas pipes and connections have no dirt. Gas connection is finished with external thread 3/8 ". Regarding gas connection, the following requirements shall apply:

- You must use the gas pipe with the correct dimensions, so there is no pressure loss.
- Ball gas valve should be installed in an easily accessible place and have the necessary CE mark.

5.2 Connection and replacement of the gas cylinder (LPG version)

The Galio Insert Manual is delivered together with an elastic gas linkage which, on one end is connected to the valve of the device and on the other end to the 37mbar regulator (in the twist-on version) ready to be connected to the gas cylinder. One needs to control the expiry date of both of the regulator as well as the gas linkage and if necessary (for instance: broken, cut, scratched linkage) replace the components for new ones according to national standards and norms.

The Galio Insert Manual fireplace can use metal or steel bottles or composite bottles filled with propane-butane gas or propane gas. This device features a twist-on regulator with current pressure of 37mbar. It can be replaced into a regulator with a quick-release with pressure regulator of 37 mbar.

WARNING!!! NEVER use an unstable gas connection or a regulator for other gas pressure.

Gas cylinders have two types of connectors:

- Twist-on connection: The most important thing is the black seal. Always check if the seal is present and that it hasn't been damaged during the gas cylinder replacement. Some connections have a knob to fasten them in place while others require the use of a wrench. Tighten securely (left thread). Using the tool pay attention not to fasten the connection too tightly as this may damage the seal.
- Quick-release: For this type of connection no tool is required. On/off regulation of gas connection is made through a switch on the regulator or on a special connector. In case of using a connector with a thread

regulator of an old type put a special emphasis on checking if the connecting nut has been tightly fastened with the help of wrench.

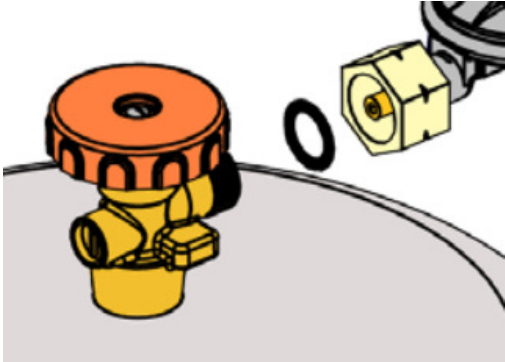
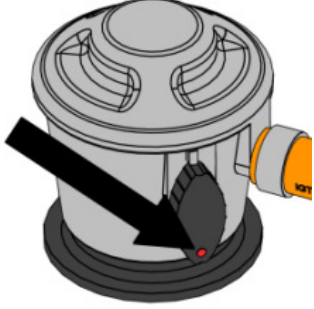
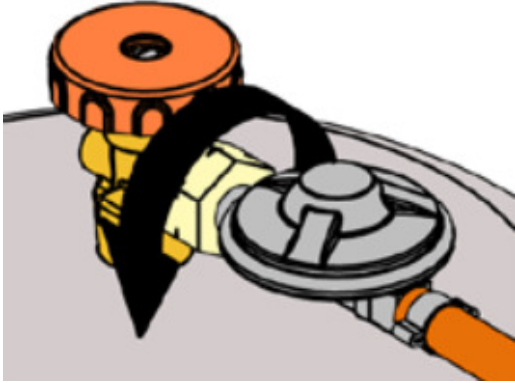
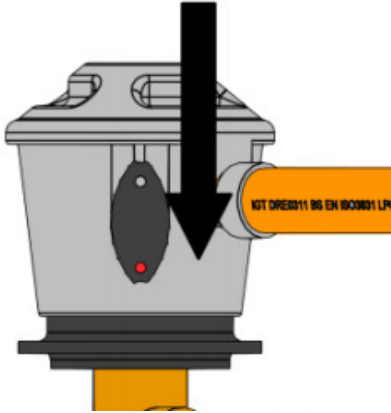
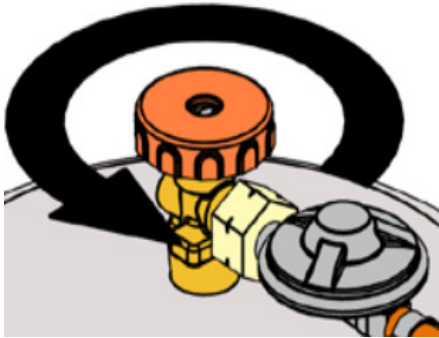
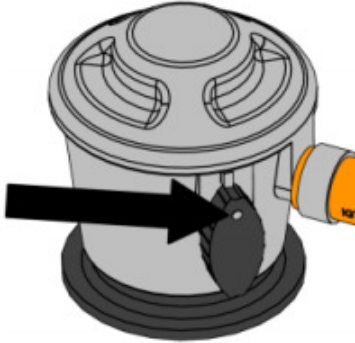

Gas cylinder connection

Twist-on connection	Quick-release
<ol style="list-style-type: none"> 1. Check if the bottle valve is TURNED OFF turning it clockwise 2. Remove the protection tip and store it for later use. 	<ol style="list-style-type: none"> 1. Remove the protection tip. Do not use any tools, leave the tip hanging freely.
<ol style="list-style-type: none"> 3. Before making the connection check if the black seal is not damaged. 	<ol style="list-style-type: none"> 2. Make sure all the taps on the gas device are closed and if the switch in in the OFF position. 
<ol style="list-style-type: none"> 4. Fit the connecting nut to the cylinder with the use of a correct wrench or the connecting knob. (left thread) Do not allow the gas cylinder connectors to be fastened too tightly. 	<ol style="list-style-type: none"> 3. Place the quick-release regulator on the valve and press it down hard. If the switch is correctly turned off you will hear a characteristic click. 
<ol style="list-style-type: none"> 5. When the gas flow is required turn the valve of the bottle counter-clockwise. 	<ol style="list-style-type: none"> 4. To let the gas flow in turn the switch into the ON position (or into the flame image). 

- Place the gas cylinder in a correct distance from the fireplace (min 1,5 metres away).

- **WARNING!!!** Check the gas connection for leakage. If anything suggests a leak is present (for instance a characteristic gas smell) close the gas cylinder valve and under no circumstances turn the device on before removing the leak.
- After removing the leak one may open the gas cylinder valve again.

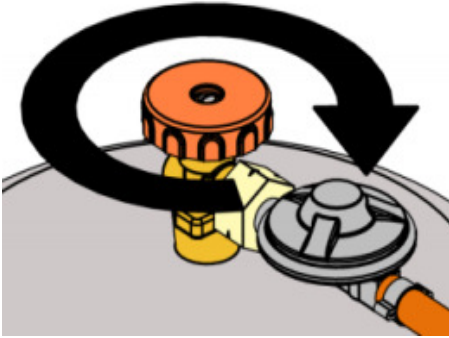
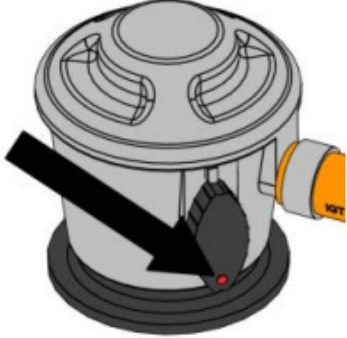
Disconnection of the gas cylinder

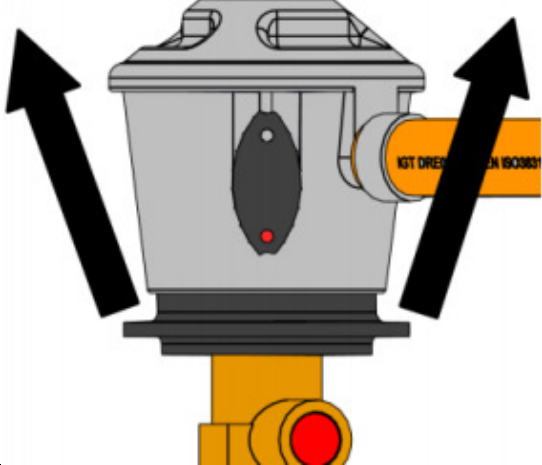
Twist-on connection	Quick-release
1. Turn off the Galio Insert Manual – put it into the OFF position. The main and pilot burner need to be turned off.	
2. Turn the bottle valve into the OFF position (clockwise). 	2. Turn the switch into the OFF position. 
3. NEVER DO NOT unmount the regulator (or connecting nut) when the bottle valve is open. 4. TAKE OFF the regulator (or the connecting nut) with the use of a wrench or a connecting knob. 	3. Take off the quick-release regulator by pressing the switch horizontally and simultaneously pulling the whole regulator upwards. 
5. REPLACE the linkage closer or cap on the empty or partially full bottle if it's not being used.	4. REPLACE the tightening cap on an empty or partially full bottle if it's not being used.

5.3 Pressure regulator replacement (LPG version)

1. You always need to use a pressure regulator between the gas cylinder and the device. Replace the pressure regulator every 5 years. Allowed pressures: 30 mbar, 37 mbar (recommended), 50 mbar. Use only the redactors that comply with the EN16129 European Norm.
2. Turn off the Galio Insert Manual – the „OFF” position. The main burner and the pilot burner need to be turned off.
3. Disconnect the regulator from the gas cylinder (description above).

4. Loosen the metal clamp with the use of a screwdriver (philips) or a flat wrench.



5. Move the clamp away from the stub of gas regulator.



6. Take off the linkage from the stub of regulator.



7. Attach a new linkage on the stub of regulator.



8. Move the clamp into the stub again and tighten it. **WARNING!** In the event of visible damage on the clamp, replace it for a new one.



6. OPERATING INSTRUCTIONS

The Galio Insert Manual fireplace has a control valve with a built-in ignition for the main burner (without pilot flame). The flame height of the main burner may be appropriately regulated with by turning the knob. Next to the knob is placed elective ignition button (powered by AAA battery). The control panel is placed on one of the shorter sides of the base of the fireplace (Photo 3).



Photo 3

6.1. Start-up of the device

- Make sure that the knob is placed in „OFF” position (all the way clockwise) (Photo 4).



Photo 4

- Open the valve on gas cylinder.
- Press the knob and while still pressing turn it counter-clockwise from position (1) to position (2)



Photo 5

- While keeping the knob still pressed start the flame by pressing the ignition button (3).



Photo 6

- A spark will appear which ignites the main burner on the minimum flame height. If the flame did not ignite repeat this process 2-3 times. This will be required especially when you have replaced and installed a new LPG gas cylinder.
- When the flame is ignited keep holding the knob for around 5 seconds until the thermo-couple, which will keep the main valve in an open position, warms up.
- You may now release the knob. If however the flame is extinguished repeat the process once again until a stable flame is achieved.
- **WARNING!!!** After 2-3 unsuccessful attempts terminate and check the connections. Try again in 10 minutes. If the installed gas bottle is new or the fireplace has not been used for a longer period the first thing that needs to be done is to release air from the gas linkage. In this case conducting a few attempts will be needed until the flame is ignited.

6.2. Regulation of the flame size

- When the flame is burning the desired height of the flame may be adjusted and regulated by turning the knob clockwise or counter-clockwise.
- To achieve a higher flame turn the knob clockwise to “Hi” position. To achieve a lower flame turn the knob counter-clockwise to “Lo” position (Photo 7).



Photo 7

6.3. Device shutdown

- To turn off the device, simultaneously press and turn the knob all the way clockwise (Photo 8). The gas supply will be cut and the flame on burner will be turned off.



Photo 8

- Additionally, close also the valve on the gas cylinder.

6.4. Replacing the battery

If the battery is inserted incorrectly, the electronic ignitor may be irreparably damaged. Only replace the battery when the appliance has been completely switched off.

The battery is placed in the container located on the control pane next to the flame regulation knob

- Unscrew the ignition button



- Remove the battery and place the new one into the container. **WARNING!** Remember about proper polarization of the battery.



- Screw the cover of the battery container.

7. TESTING

WARNING!!! NEVER TURN ON THE DEVICE IF THE CHARACTERISTIC SMELL OF GAS IS PERCEPTIBLE.

If you smell gas during the operation of the fireplace turn off the device immediately and cut off the gas supply from the gas cylinder by shutting its valve.

7.1. Checking for gas leaks.

- Check if all connections are airtight.
- To do that apply all connections with soapy water (or water with another foamy substance) or with a professional spray for leak detection.
- If air-bubbles are present that means the connection has a leak.
- Remove the leaks in the identified spaces.
- Check for leaks once again.
- After the inspection dry the inspected connections.
- The device may only be used again after all leaks are removed.
- **If the problem happens again please contact the dealer.**

7.2. Checking the flame appearance.

- Burn The Galio Insert Manual on max flame height and check the appearance of the flame.
- The flame should be linear and evenly placed on the whole length of the main burner.
- If visible gaps are present or there are substantial differences in flame height turn off the fireplace and after the device is cooled adjust the placement of decorative stones in such a way for them to be evenly placed on the whole surface of the main burner.
- **WARNING!!!** Remember not to cover the cover, which houses the ignition and the pilot flame, with stones.
- Turn on the fireplace and check the appearance of the flame once again.

8. MAINTENANCE AND UPKEEP

We recommend cleaning the pilot flame and the main burner unit before the device is started again after its been removed from storage during the winter period.

8.1. Testing and cleaning

Please check and clean if necessary:

- The main burner - if necessary, remove broken parts of stones and the existing dust.
- Pilot burner and thermo-couple (if necessary, remove the existing sediment). In the event of visible damage contact your dealer.
- Igniter - gap between igniter and pilot flame should not be bigger than 5 mm.
- Glass screens – check for dirt smudges or possible scratches or cracks. If cracks are present replace the glass screen for a new one. To conduct this contact your dealer.
- Gas linkage and pressure regulator (in case their expiry date is invalid replace these ancillaries for new ones).
- If you encountered problems with the regulator, gas linkage, burner or regulation valves do not try to fix these parts. Contact a sales person, an authorised service or an importer in order to acquire spare parts. To ensure the device is working efficiently use only original spare parts.

8.2. Glass cleaning

Most of the existing types of smudges may be wiped with a dry cloth. In case of more substantial smudge you may use liquids normally applied to ceramic tiles or windows. Always dry the glass screen to avoid damp patches which could irreversibly embed into the glass.

WARNING!!! Avoid leaving fingerprints on the glass. They will be embedded into the glass and you will not be able to clean them.

9. TROUBLESHOOTING

Warning! Montage, upkeep and service need to be conducted by a qualified professional with appropriate qualification, an appropriate company or the gas supplier.

PROBLEM	POSSIBLE CAUSE	CORRECTIVE ACTION
SMELL OF GAS	CLOSE THE VALVE ON THE GAS CYLINDER IMMEDIATELY. DO NOT USE THE DEVICE UNTIL LEAKS HAVE BEEN REMOVED.	
Leak detected at cylinder, regulator or other connection.	<ol style="list-style-type: none"> 1. A loose regulator linkage. 2. Leak in the gas linkage, in the regulator or on the gas knobs. 	<ol style="list-style-type: none"> 1. Tighten and test it. 2. Report this issue to service.
Burner does not ignite	<ol style="list-style-type: none"> 1. The bottle is empty. 2. Igniter linkage is not connected. 3. No ignition spark. 4. The igniter electrode is placed incorrectly opposite the igniter. 5. Gas nozzles are blocked. 6. Gas linkage is twisted. 7. Pressure regulator link is loose. 	<ol style="list-style-type: none"> 1. Replace Gas Cylinder. 2. Connect the igniter linkage. 3. Replace igniter. 4. Realign electrode and clear any surrounding debris from area. 5. Unmount burner, clean the nozzle. 6. Straighten the linkage. Keep the linkage away from the housing. 7. Tighten the link. Check for leaks.
Igniter Not Working	<ol style="list-style-type: none"> 1. Ignitor wire not connected. 2. Electrode misaligned on pilot burner 3. Igniter malfunction 4. The battery has run out 	<ol style="list-style-type: none"> 1. Ensure pilot electrode wire is connected. 2. Realign electrode and clear any surrounding debris from area. 3. Replace Igniter 4. Replace battery
Low efficiency, „cracking” sounds	<ol style="list-style-type: none"> 1. The bottle is empty. 2. The nozzles of the burner are blocked. 	<ol style="list-style-type: none"> 1. Replace Gas Cylinder. 2. Unmount the burner, clean the nozzle.
Thumping sounds made by the regulator.	The cylinder valve has opened rapidly.	Unfasten the bottle valve slowly.
A vivid/ bright orange and smoky flame of the burner.	Holes blocked in the apparatus producing the gas and air mixture.	Unmount the burner and clean/ unblock the apparatus' holes.

10. TECHNICAL SPECIFICATION

Appliance Category		I3P			I3B/P			I3+		I2H/E	I2L
Gas type		G31			G30			G30	G31	G20	G25
Gas pressure	[mbar]	30	37	50	30	37	50	28-30	37	20	25
Injector diameter	[mm]	2,0							2,7		
Burner Pressure	[mbar]	30	37	50	30	37	50	28-30	37	20	25
Gas consumption	[g/h]	0,84	0,93	1,08	0,84	0,93	1,08	0,80-0,84	0,93		
	[m3/h]									1,22	1,37
Nom. Input (Hi)	[kW]	10,6	11,8	13,7	12,1	13,5	15,6	11,7-12,1	11,8	13,6	15,3
Safety device	Thermocouple										
Gas control valve	BS190										
Flexible hose (4 m)	Ø9mm										

11. MANUFACTURER'S CONTACT DETAILS

Manufacturer: Planika Sp. z o.o.
Address: Bydgoska 38
 86-061 Brzoza
 Poland
Telephone: + 48 52 364 11 60